

Pin Assignment

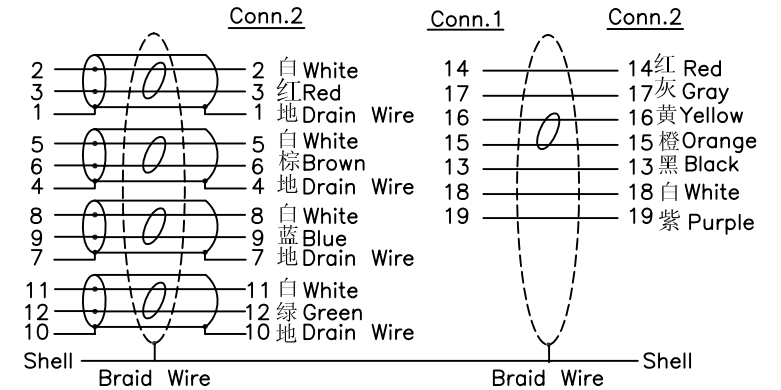

注意事项:

2. 锡点不易过大。

NO	ITEM	DESCRIPTION	Q'TY	UNIT	REV.	TOLERANCE			DESCRIPTION	DATE				
						INCHES	M/M							
8	A6-0000030	MINI HDMI M 透明PVC防尘盖	2	pcs					<p>TITLE: HDMI CM/CM 30AWG 客人模具 镀金</p>					
7	A10-R075133	黑色热缩套管: $\phi$ 1.5*16mm 厚壁	2	pcs										
6	A10-R065324	黑色热缩套管: $\phi$ 2.0*8MM 薄壁	8	pcs										
5	A10-R075205	黑色热缩套管: $\phi$ 0.6*6MM 薄壁	8	pcs										
4	A5-R047001	45P 黑色 PVC料 环保	12	g					CUSTOMER :	亚晴				
3	A5-R047011	透明 PE料 环保 低密度	3	g					CUSTOMER NO.:					
2	A2-R020095	MINI HDMI M 19P 带PCB板 铁壳镀金3U 端子镀金15U 黑色胶芯	2	pcs					SCALE	NONE	DRAWING NO.:	REV. A		
1	A4-R001349	UL20276 (30AWG*1PR+EAM)*4C+30AWG*1PR+30AWG*5C+AEB 50%铝编 OD:5.5MM 黑色 印:HIGH SPEED HDMI® ...	0.3	m					UNIT	MM			CAG460003	1/2
									DATE	10.11.03				
									DRAWN BY	alex				
									CHECK BY					
									APPD BY					

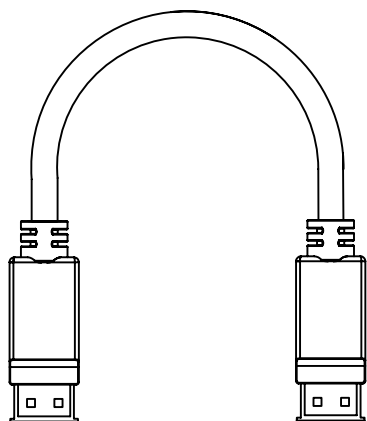

依图示绕线

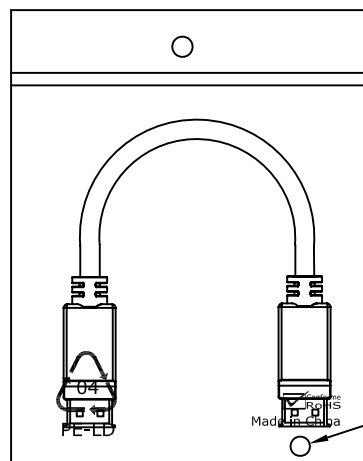
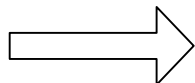

单PCS装夹链袋

透气孔

包装方式:

- 1.如图所示在纸箱里放一防水袋，每箱装300PCS，上中下放一纸板，用透明胶纸封口。
- 2.纸箱正侧唛内容如订单填写，手写需字迹工整或盖章。
- 3.为防纸箱空箱现象或美观性可适当增加纸板。

正唛:

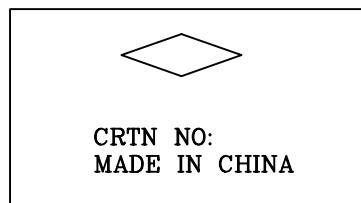

侧唛:

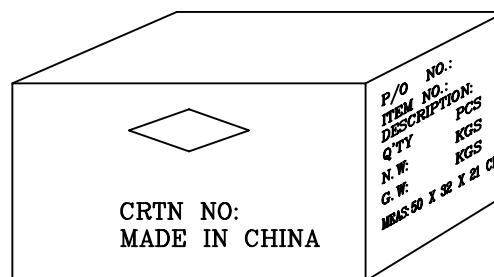
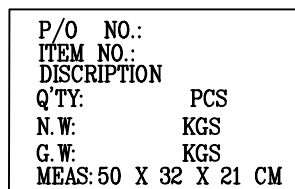

NO.	CELINK P/N	DESCRIPTION	Q'TY	UNIT	REV.	TOLERANCE		DESCRIPTION	DATE		
					①	INCHES	M/M				
					.X	.015	.30	 TITLE: HDMI CM/CM 30AWG 客人模具 镀金			
					.XX	.010	.10		CUSTOMER :	亚晴	
					.XXX	.005	.05		CUSTOMER NO.:		
4	A8-R053011	防水袋 850*750*0.06MM 不印字	1/300	pcs	DRAWN BY	alex		SCALE	NONE	DRAWING NO.:	REV.
3	A9-H005006	纸板 B3C 480X300MM	4/300	pcs	CHECK BY			UNIT	MM		CAG460003
2	A9-H005003	纸箱 K=K 500X320X210MM 标准印字	1/300	pcs	APPD BY			DATE	10.11.03		
1	A8-R053069	夹链袋 100*200*0.06MM 印带环保标志和RoHS...(打透气孔和挂孔)	1	pcs							

Cable comparison	PCIEMM-xxx	PCIEMM-xxxA
Cable Length	PCIEMM-030 30CM PCIEMM-060 60CM PCIEMM-100 100CM	PCIEMM-010A 10CM PCIEMM-015A 15CM PCIEMM-030A 30CM PCIEMM-060A 60CM PCIEMM-100A 100CM PCIEMM-150A 150CM PCIEMM-200A 200CM PCIEMM-300A 300CM PCIEMM-400A 400CM PCIEMM-500A 500CM
Cable specification Connector	HDMI 1.3c Mini HDMI	HDMI 1.4b Mini HDMI
Interface	Custom PCIe cable	Custom PCIe cable
Cable Appearance	circle 	flat 